



KEANLEY

TRS-130X

RS232&485 to SDI-12

Converter/User Manual

Beijing Keanley Technology Co.,Ltd



CONTENTS

01 . What are the characteristics/application scenarios of SDI-12/TRS-130X.....	1
02 . Description of interface indication.....	2
03 . Devices connection diagram.....	3
04 . Basic parameters and dimensions.....	4
05 . Absolute maximum rating/electrical characteristics.....	5
06 . Introduction of SDI-12.....	6
07 . Set TRS-130X.....	7
08 . Transparent transmission protocol.....	9
09 . Start sensor measurement.....	14
10 . Obtain sensor data.....	16
11 . Recommended SDI-12 circuit.....	18
12 . Commands and replies of SDI-12.....	19
13 . Connectable sensor brands.....	21

KEANLEY

What is SDI-12?

SDI-12 (Serial Digital Interface) is a serial digital interface with a baud rate of 1200. The SD-12 communication standard, a serial data communication interface protocol widely applied in environmental monitoring around European and American countries in recent years, is now widely used in multi-parameter measurement and control of industry and agriculture, hydrological and meteorological monitoring of rivers, lakes, and seas, as well as in animal husbandry and food production, through which data can be transmitted over long distances.

Features of TRS-130X

- Transparent mode bidirectional data logger.
- Fully comply with SDI-12.
- Send SDI-12 command and return a response.
- Low energy consumption.
- Using single or multiple sensors in one cable.
- Multiple indicator lights of operational status.
- This device can be used for long-term unmanned operations.
- A 1000 m cable length can connect up to 10 sensors.

Application scenarios

The SDI-12 Interface Protocol Converter, an advanced device widely used in fields such as agriculture, environmental monitoring, meteorological research, and hydrological measurement, etc., has features of high reliability, stable performance, and easy operation, which can effectively convert data between SDI-12 interface and other interfaces, providing users with a convenient and fast user experience.

In the field of agriculture, the SDI-12 Interface Protocol Converter can convert the soil moisture, temperature, gas concentration and other data measured by sensors into general analog or digital signals for output through the SDI-12 interface, so that users can better control the growth environment of crops and improve yield and quality. In addition, it can also be integrated into irrigation systems, automatically adjusting the irrigation amount based on soil moisture conditions, thus, achieving intelligent agricultural management.

In terms of environmental monitoring, the SDI-12 Interface Protocol Converter can output measurement data from various environmental parameter sensors through the SDI-12 interface, including air temperature and humidity, air pressure, wind speed and direction, to meet the needs of environmental monitoring. For example, in meteorological research, researchers can integrate data from various meteorological parameter sensors into the meteorological station system via this product, accurately monitoring and predicting meteorological changes, and providing convenience for meteorological forecasting.



TRS-130X Interface Converter

In addition, the SDI-12 Interface Protocol Converter also plays an important role in the field of hydrological measurement. By converting the data measured by sensors such as water level, flow rate, and rainfall into SDI-12 interface outputs, real-time transmission and remote monitoring of hydrological observation data can be achieved, which is of great significance for water resource management, flood warning, and river flow regulation, etc.

The SDI-12 Interface Protocol Converter is simple to operate. Data transmission and processing can be achieved only by connecting the sensor to the converter which is connected to a data acquisition system or a computer. Meanwhile, it supports data recording and storage functions, allowing users to query historical data at any time and perform data analysis and comparison. In addition, various output interface options are provided, including RS485, RS232, USB, etc., so that users can choose the interface according to their actual needs.

In summary, the SDI-12 Interface Protocol Converter, a high-performance, reliable, and easy to operate device, could be widely applied in fields like agriculture, environmental monitoring, meteorological research, and hydrological measurement. Fast and accurate data transmission and analysis processing can be achieved by seamlessly integrating with various sensors, providing users with a comprehensive solution. No matter you are an agricultural producer, an environmental researchers, or a hydrological observation professionals, you can definitely rely on this powerful device to better carry out your work and achieve better results.



Description of interface indication

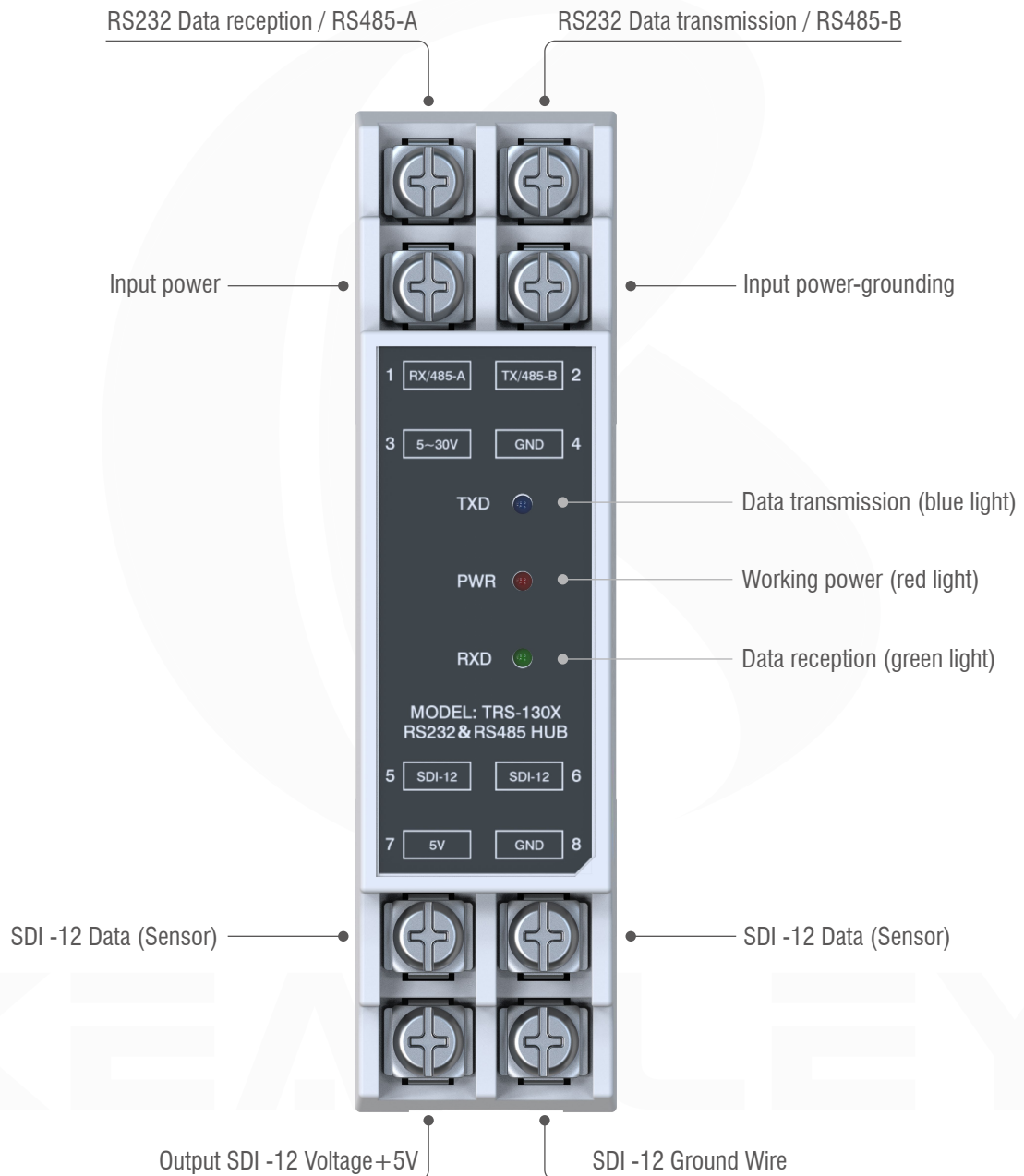

Devices connection diagram





Basic parameters

- Input voltage: DC 3.6V-30V
- Static power consumption: 12V@96uA
- Transmission distance: 1200 meters
- Power output: 5V@250mA
- Baud rate: 1200
- Communication protocol: Standard SDI-12 transparent transmission
- Working temperature: - 40°C~70°C
- Number of supporting addresses: 62
- Applicable operating system: Windows, Linux and Apple

Dimensions

Unit: mm

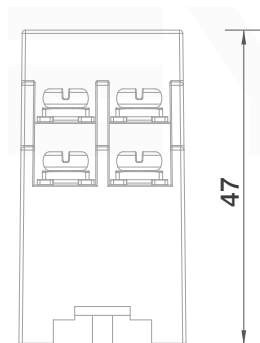
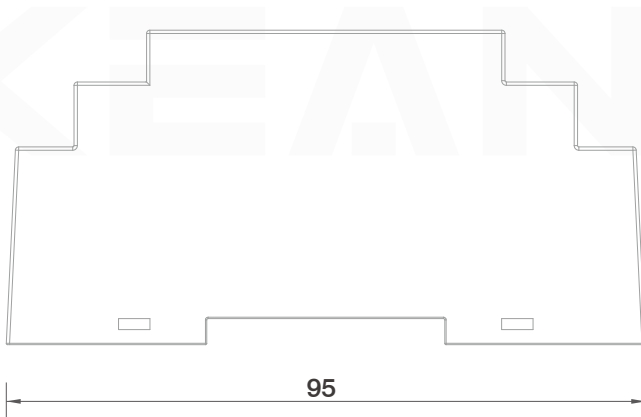

Absolute maximum rating/Electrical characteristics

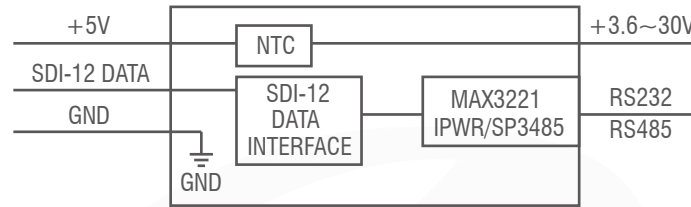

Figure 1. TRS-130X block diagram

Stress exceeding the limits listed in the table below may lead to permanent failure. Long term exposure to absolute ratings may affect equipment reliability. The limit values comply with the absolute maximum rating system (IEC 134). All voltages are based on the ground.

Symbol	Parameter	Condition/Status	MIN	MAX	UNIT
	SDI-12 DATA		-0.3	5.1	V
	SDI-12 POWER		3.6	30	V
VES	Electrostatic treatment		-	2000	V

Table 1. Absolute maximum rating

Temperature $T_A=20^{\circ}\text{C}$.

Symbol	Parameter	Condition/Status	MIN	TYP	MAX	UNIT
SDI-12 Data Terminal						
VIL	Input low voltage level		-0.3	0.0	0.8	V
VIH	Input high voltage level		2.8	3.6	5.0	V
VOL	Output low voltage level		-0.3	0.0	0.8	V
VOH	Output high voltage level		4.5	4.8	5.1	V
SDI-12 Power Terminal						
V_SDI_Out	Sensor power supply voltage		4.95	5.0	5.1	V
I_SDI_Out	Sensor power supply current		-	-	250	mA
Working temperature range			-40 ~ 70			$^{\circ}\text{C}$

Table 2. Electrical characteristics



Introduction of SDI-12.

SDI-12 is specifically designed for communication between sensors and data loggers. It fully defines the hardware, network and application layers. It has the function of assigning addresses to sensors and synchronously and asynchronously requesting readings. Any sensor with SDI-12 enabled can be connected to any data logger with SDI-12 enabled. The only practical limitations are the power consumption and voltage of the sensor. The SDI-12 bus has a common power supply cord for all sensors. The comprehensive power consumption should not exceed the capacity of the data logger. All sensors should be able to work within the power supply cord voltage. If the power supply cord of the data logger can't meet the power requirements of the sensor, an external power source can be introduced. However, this will make the system more complicated and less practical. SDI-12 is a master-slave network. Each sensor has a unique address. There can be up to 62 different addresses (0.1, a.. z, a.. z) with a maximum cable length of approximately 70-100 meters.

The most unique feature of this protocol is its sleep and wake-up mechanisms identified as 12 ms and 8.33 ms. Due to the low power consumption mode of the SDI-12 sensor, it enters sleep mode when not in operation. Therefore, a 12 ms identification signal needs to be added before each command to wake up all sensors on the bus. After the sensor wakes up from the low power mode and receives the next 8.33 ms identification signal, it begins to search for a matching address, and the address matching begins to measure. If the address is invalid or idle for over 100 ms, it will return to low-power consumption standby mode. Note: This feature is automatically executed by the data logger or SDI-12 protocol converter.

SDI-12 has the following advantages over other commonly used communication standards.

1. The hardware structure is simple. Only one power supply cord and one data cable are required. And the level definition of the data cable is basically the same as that of the MCU, without the need for complex conversion circuits.
2. SDI-12 has a hardware wake-up function, which requires a wake-up operation before each communication. Therefore, SDI-12 sensors can enter sleep mode when not awakened to reduce sensor power consumption.
3. The SDI-12 protocol commands are in readable text format and the command structure is simple, making it easy for on-site technicians to directly use the console for debugging, as shown in Figure 2.

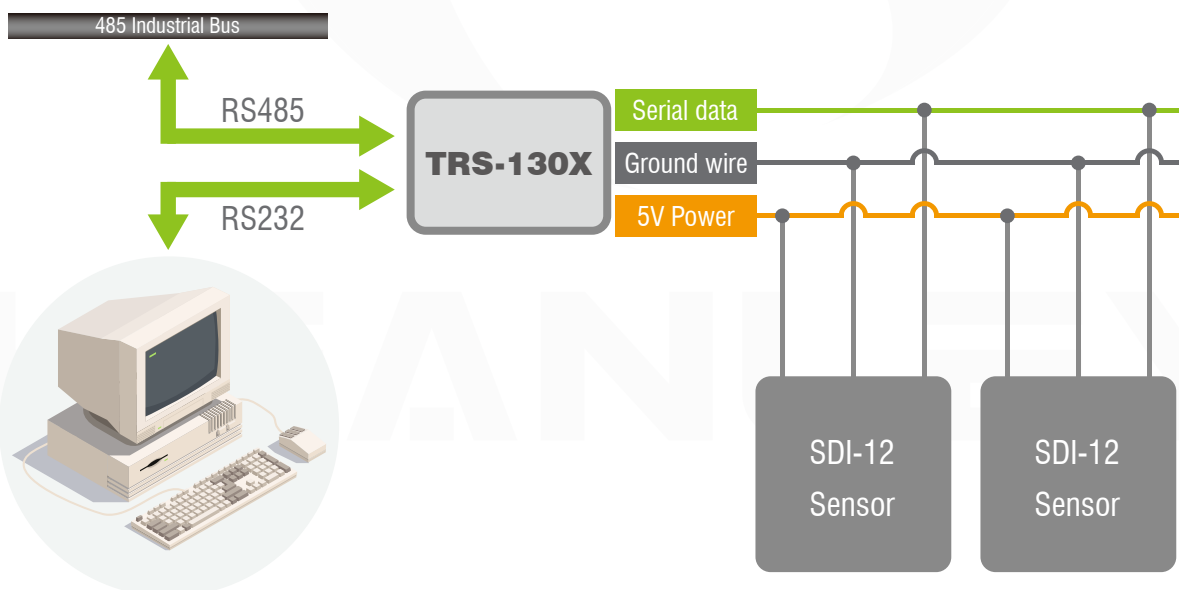

Figure 2. Principle diagram



Set TRS-130X

1. TRS-130X converter system hardware connection.

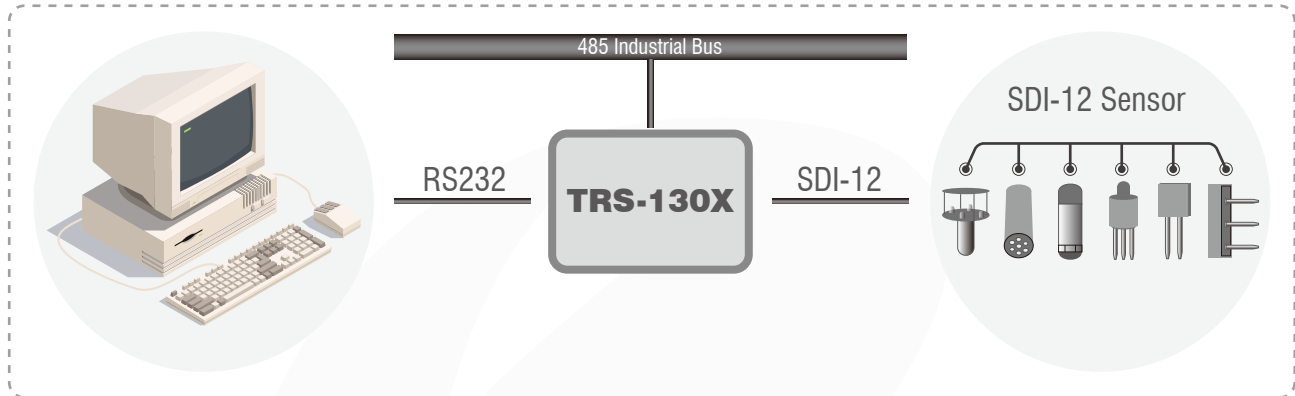

Figure 3. Diagram of converter hardware connection

- RS232 is used to connect computers or industrial control computers with a COM port (DB9 female port is connected to the 2-pin RX and 3-pin TX of the PC/male port through a cable plug).
- RS485 interface is used to connect industrial bus devices (A connect to A, B connect to B).

2. Viewing of TRS-130X converter serial port number.

- Using RS232 for communication.
- The current communication port number is COM1 which can be viewed in the Device Manager.

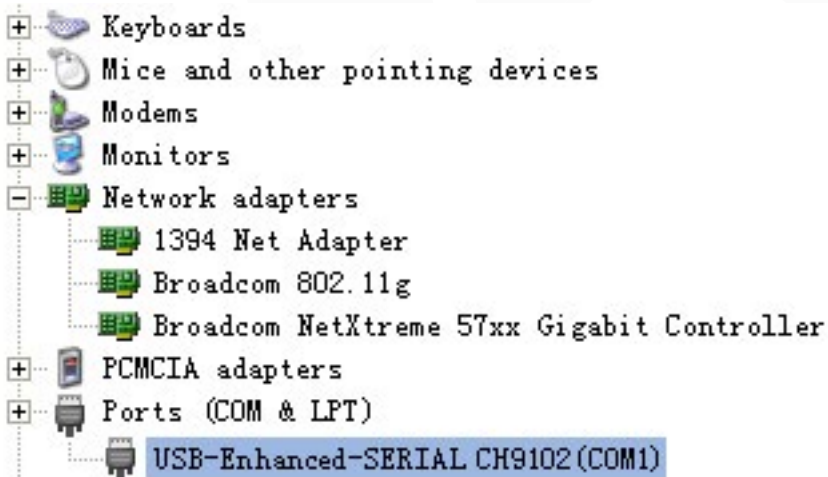

Figure 4. Computer device manager view

3. Communication configuration of TRS-130X converter.

Communication Configuration				
Start bit	Data bits	Parity bit	Stop bit	Baud rate
1	7	Even (even parity check)	1	1200 (fixed)

Table 3. Communication configuration



4. Introduction of obtaining and using SDI-12 interface conversion software.

The SDI-12 interface conversion software is specifically developed for communication debugging of SDI-12 series products. It has a layout setup interface by region, simple and easy to set, and meets all operations of TRS-130X products.

- The download link of SDI-12 interface conversion software is listed in the following box.

Download link of serial port debugging software driver (Chinese/English):
<http://www.keanley.com/download.html>

- Double click to open the downloaded file "SDI-12 Interface conversion.exe" as shown in Figure 5 below.

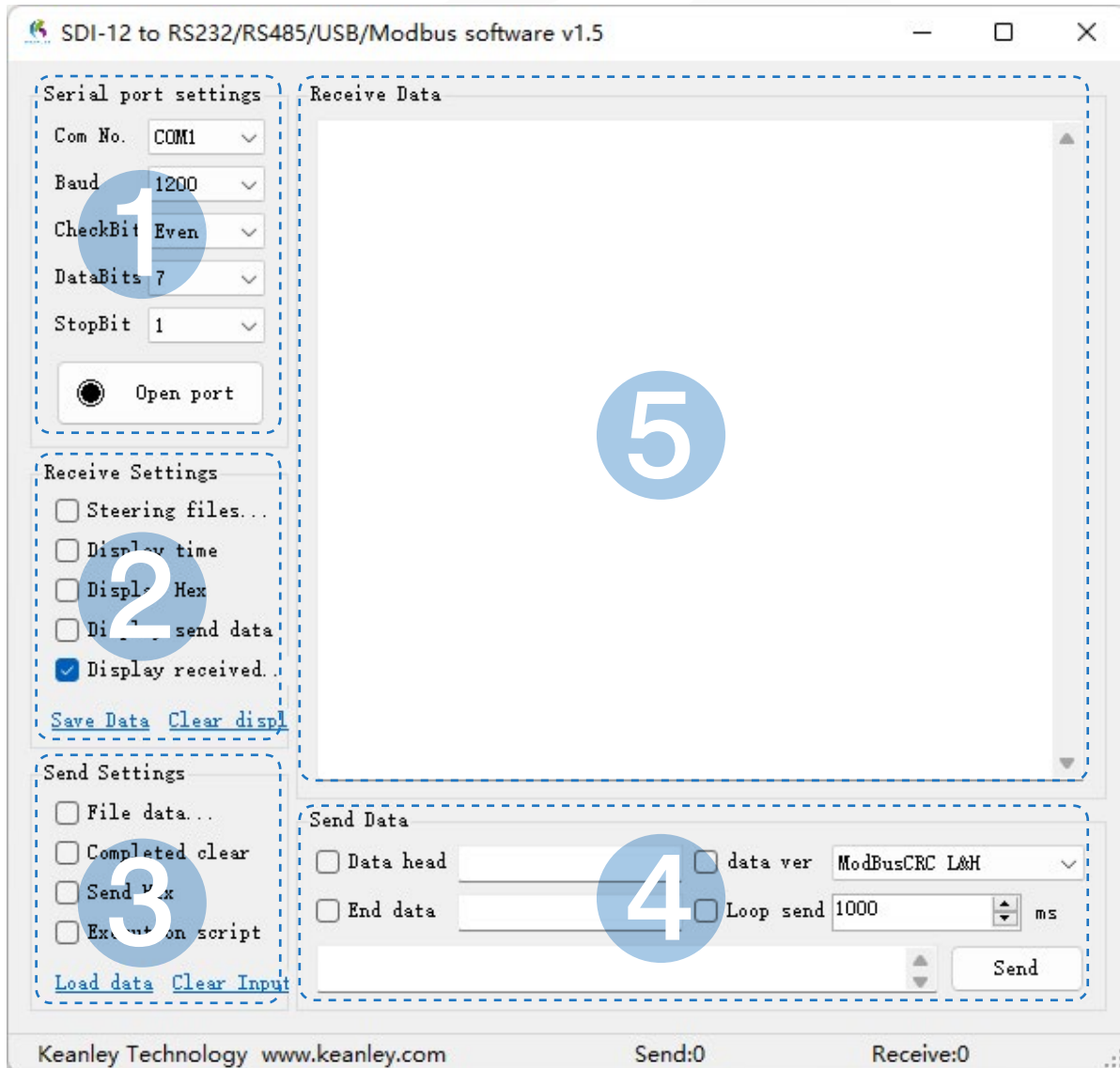

Figure 5. Software initial interface

As shown in Figure 5, the interface conversion software is divided into five regions.

- Refer to Table 3 on page 7 for the setting of the serial port setting area.
- Check in order of 2-4-5 from top to bottom in the setting area of receiving.
- No need to check when sending the SDI-12 mode in the setting area.
- To send the SDI-12 of data area , only input the corresponding command in the sending bar. No need to check the rest.
- The receiving data area will display the current sending data and the instantly returned data.



Transparent transfer protocol

1. Analysis of the composition of SDI-12 transparent transport protocol.

1. All commands sent on the SDI-12 bus must be ASCII codes, with a maximum of 5 characters. All commands sent must start with an address code and end with "!".
2. The specification of SDI-12 stipulates that the address range is the digits "0-9, a-z, A-Z", and generally the initial address is the digit "0".
3. Command format, such as aM!, is a measurement command, where "a" is the address, "M" is the command to start the sensor measurement, and "!" is the end symbol of the command. These three symbols constitute a complete command.
4. After the command is issued, the sensor will respond accordingly. Still giving the aM! example above, the response result of the sensor is "attn" at this point, in which "a" is the address, "ttt" is the measurement time with unit in second, and "n" is the quantity of data.

2. The standard SDI-12 byte frame format is as follows (with a fixed baud rate of 1200).

SDI-12 Byte Frame Format			
Start bit	Data bit	Parity check Bit	Stop bit
1	7	1	1

Table 4. SDI-12 byte frame format

3. SDI-12 time sequence.

All SDI-12 commands and responses must follow the format shown in Figure 6 of the data line. The two commands and responses, preceded by an address and combined with a carriage return and line feed (<CR><LF>), are operated in the time sequence shown in Figure 7.

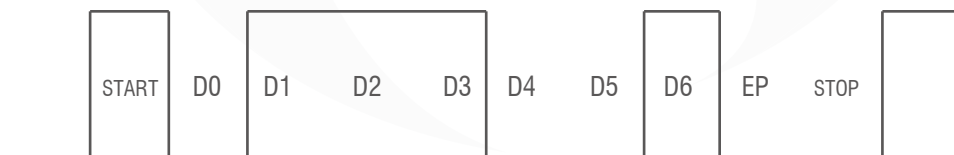

Figure 6. Example of SDI-12 transmission character 1 (0x31)

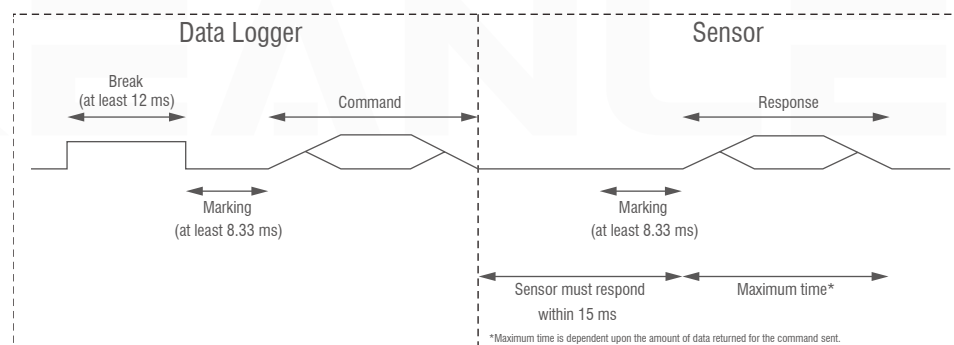

Figure 7. Communication example of the data logger and the sensor



4. Device address.

ASCII codes "0" to "9" are standard addresses that must be supported by all sensors and data loggers. When more than 10 sensors are needed, A~Z (65-90) and a~z (97-122) will be used.

ASCII Address (Single Character)	Decimal	Hexadecimal	Description
"0"	48	30	The factory default addresses of all sensors are set to 0 for the convenience of a single sensor
"1"~"9"	49~57	31~39	Multiple sensor addresses on the SDI-12 bus

Table 5. Device address

5. The measurement sequence process of a typical TRS-130X data loggers and sensors is as follows.

Step 1. The data logger wakes up all sensors on the SDI-12 bus through an interrupt signal (at least 12 ms of continuous blank numbers).

Step 2. The data logger sends commands to the sensor identified at a specific address, indicating it to conduct a measurement.

Step 3. The sensor at the specified address responds within 15 ms, including the maximum time required to obtain measurement data and the number of measurement data to be returned.

Step 4. If the measurement data is instantly available, the data logger sends a command to the sensor to indicate that it returns a measurement data ready request. The data logger sends a measurement data return command.

Step 5. Sensor response, returns one or more measurement data.

6. Commonly used SDI-12 commands and replies.

Name	Command	Reply
Interrupt signal	Continuous 12 ms blank number	None
Confirm activation	a!	a<CR><LF>
Send verification	a!	Allccccccmmmmmmvvvxx...xx<CR><LF>
Address change	aAb!	B<CR><LF> (This command is only supported when the sensor supports software to change the address)
Address query	?!	a<CR><LF>
Start measurement	aM!	attn<CR><LF>
Send data	aD0!...aD9!	a<values><CR><LF>
Continuous measurement	aR0!...aR9!	a<values><CR><LF>

Table 6. SDI-12 basic commands/replies (more commands can be found in the final attachment)

The first character of all commands and replies is always the device address. The last character of the command is "!". The last two bytes of the reply are carriage return and line feed (<CR><LF>). In replies to command D, the maximum number of characters for the <values> section is 35 or 75.



■ Confirming activation command (a!)

This command is used to confirm that the sensor can respond properly to data logger or other SDI-12 devices to determine its presence on the SDI-12 bus, as shown in Table 7 below.

Command	Reply
a!	a<CR><LF>
a-Sensor address	a-Sensor address
!-Command end symbol	<CR><LF> Response end symbol

Table 7. Confirming activation command (a!)

■ Sending authentication command (a!)

This command is used to query the SDI-12 version, model, and firmware version number of the sensor, as shown in Table 8 below.

Command	Reply
a!	allccccccmmmmmmvvvxxx...xxx<CR><LF>
a-Sensor address	a-Sensor address
!-Sending verification command	!! - SDI-12 version number, displaying the compatibility of SDI-12 version. For example, version 1.3, encoded as 13 xxx xx - optional area, up to 13 characters, is used for serial number or other sensor information unrelated to data logger
!-Command end symbol	<CR><LF> Response end symbol

Table 8. Sending authentication command (a!)



■ Address query command (!)

If the sensor has an SDI-12 bus address, it needs to reply to the command. For example, if the sensor receives a query command !, reply "a" no matter what its address is. This command allows the user to confirm the address of the sensor. There is only one sensor on the SDI-12 bus.

■ Changing address command (aAb!)

This command changes the address of the sensor. If the sensor supports software to change the address, it will support the address change command, as shown in Table 9. After this command is sent and responded, the sensor is allowed to not reply to other commands for 1 second. This is because time is needed for the sensor to write the new address into non-volatile memory.

Command	Reply
aAb!	b<CR><LF>
a-Sensor address	b-Sensor address (new address if successfully changed, old address if address unchangeable)
A- Changing address command	
b-New modified address	
!-Command end symbol	<CR><LF> Response end symbol.

Table 9. Changing address command (aAb!)

■ Starting measurement command (aM!)

This command tells the sensor to make measurements. But the sensor will not instantly reply to the measurement data after receiving this command. Instead, it will first reply to the time required to return the measurement data and the quantity of measurement data to be returned. To obtain the measurement data, the sending data command (aD!) must be used. The starting measurement command is shown in Table 10.

Command	Reply
aM!	attn<CR><LF>
a-Sensor address	a-Sensor address
M-Starting measurement command	ttt-Time measured in seconds, the time taken by the sensor to complete the measurement.
!-Command end symbol	n-The number of measured values, which will be returned in one or multiple D commands. ("n" is an integer number from 0 to 9).

Table 10. Starting measurement command (aM!)



■ Sending data command (aD0!,aD1!,...aD9!)

This command is used to obtain a set of data within the sensor. D0! is sent after M, MC, C, CC, V, or HA commands. The sensor sends returning data as a response. If all expected measurement data is not returned in D0 reply, the data logger will keep sending D1!, D2!,etc., until all measurement data is received. Sending data command is shown in Table 11 below.

Command	Reply
aD0!(aD1!...aD9!)	a<values><CR><LF>
a-Sensor address	a-Sensor address
D0-sending data command, D1...D9-additional data transmission	Polarity symbol+7-digit number+decimal point
!-Command end symbol	<CR><LF>Response end symbol

Table 11. Data Command(aD0!,aD1!,...aD9!)

If the response of the D command is correct but no data is returned, it indicates that the sensor has exited the measurement process. If the data logger wants to obtain data, an additional M, C, or V command must be sent. The maximum number of characters that can be returned in the <values> section of the D command reply is 35 or 75. If the data sending command D is used to receive data after concurrent measurement command or high-capacity ASCII measurement command, the maximum value is 75. Otherwise, the maximum value is 35.

■ Continuous measurement (aR0!...aR9!)

If the sensor can continuously monitor the value to be measured, such as the shaft encoder, there is no need to start measurement commands (M!, M1!... M9!). They can be read directly using the R command.

For example:

If (the sensor is in continuous measurement mode) aR0!,it will obtain and return the current value read from the sensor.

The R command (R0!... R9!) works similarly to the D command. The main difference is that the R command does not require the use of the M command to inform the sensor to perform measurement. The maximum number of characters that can be returned in the <values> section of the R command reply is 75.

Each R command is an independent measurement process, for example, there is no need for R0... R4 before the R5 command. If the sensor can't perform continuous measurement, it will return "a+<CR><LF>" as a reply. If CRC verification is required, the CRC verification code must be included before <CR><LF>, such as 0AP@<CR><LF>.



Start sensor measurement

Refer to the devices connection diagram (this data demonstration is sensor CTD-100). After a successful connection, open the interface conversion software on the computer and manually set the communication parameters, as shown in Figure 8 below.

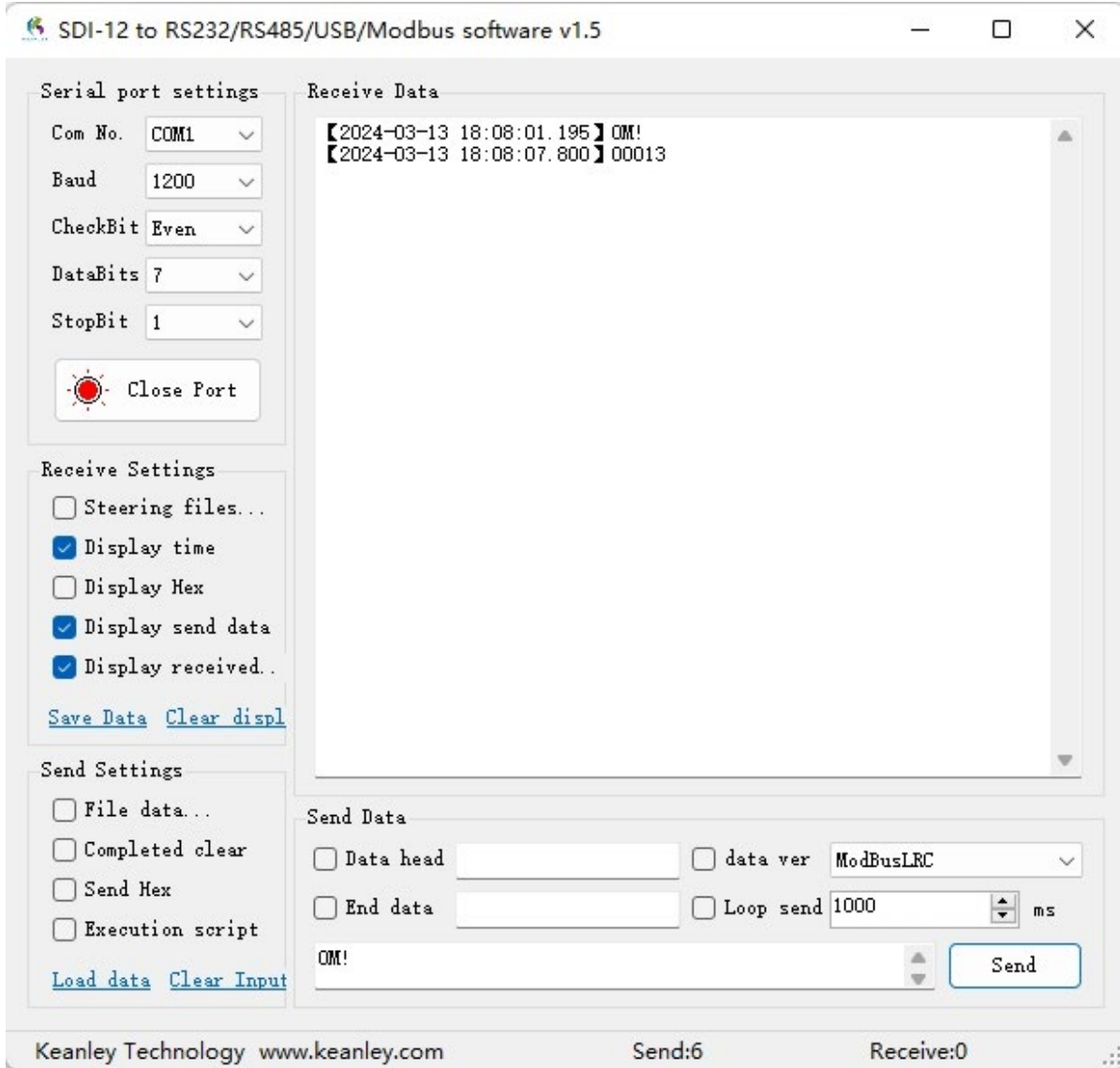

Figure 8. Setting communication parameter interface

After connecting the trs-130x, open the above serial port software interface, and set parameters according to table 3 on page 7 and page 8 (RS232 interface communication)

Step 1: Set serial port number COM1

Step 2: Set a fixed baud rate of 1200.

Step 3: Data bit 7.

Step 4: Even (Even parity check)

Step 5: Stop bit 1.

Step 6: Check the corresponding position as shown in the above figure and then click the button to open the serial interface tool (the red mark “on” indicates that the serial interface is open).

Step 7: The default initial address of the sensor is number "0". After manual sending OM! in the sending area, the second entry in the receiving data area is the returning data (00013).

After following steps 1-7 above, return to 00013. According to the parsing of the returning instruction “attn” shows that “a” corresponds to sensor address “0”, “ttt” corresponds to time 1 second, and “n” corresponds to data 3. Tracking feedback using a logic analyzer is as follows.



Send: The oscillogram feedback of OM! is shown in Figure 9.

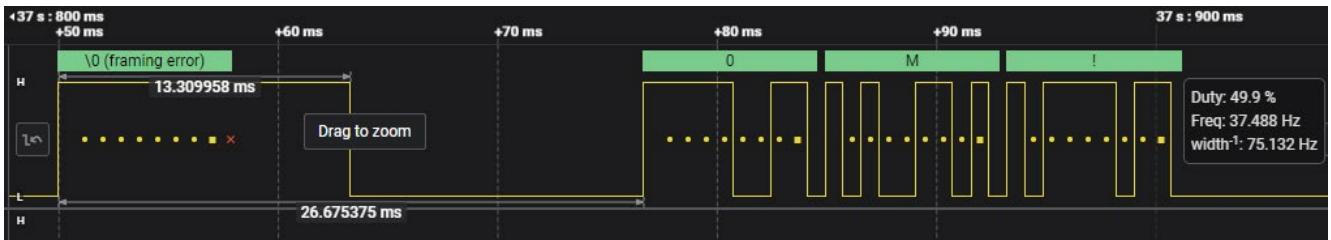

Figure 9. Oscillogram

Return: The oscillogram feedback of 00013\r\n is shown in Figure 10.

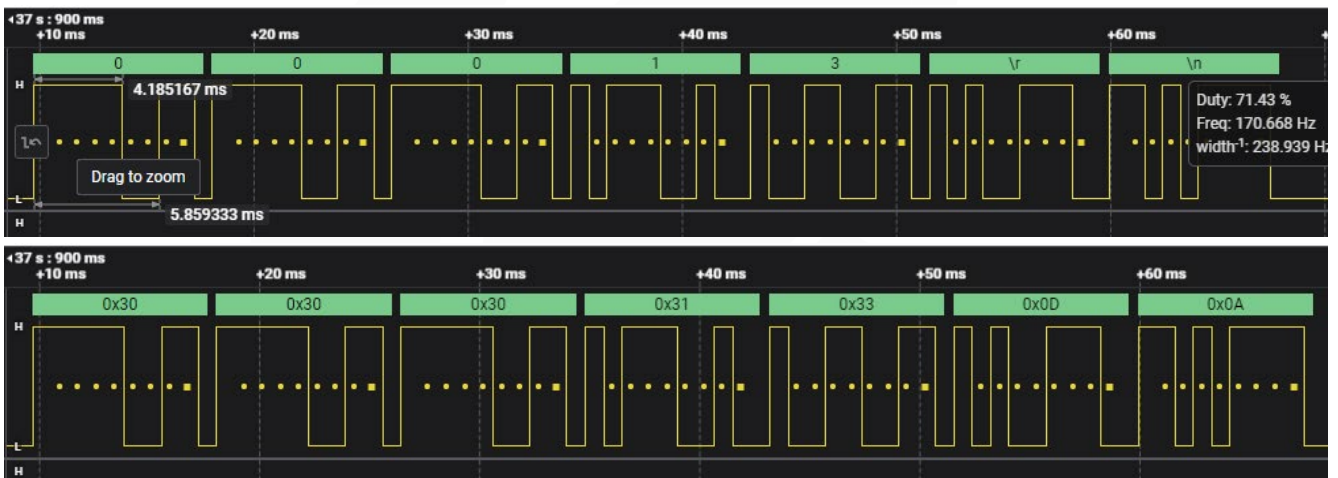

Figure 10. Oscillogram

The oscillogram of the hexadecimal number 0X0D corresponding to the \r characters in the return value character 00013\r\n is shown in Figure 11.



Figure 11. Oscillogram

The above waveform is parsed as follows:

- 0x0D--Binary-->00001101.
- Since the original data contains three 1, the check bit is 1.
- Sort from right to left as 10110000.
- Replace the rightmost digit 0 with 10110001 by check bit 1 .
- Adding the start and end bits gives 0101100011.
- Inversion means that 1010011100 corresponds to the logical high and low levels in the oscillogram.



Obtain sensor data

Obtain CTD-100 sensor data in SDI-12 mode.

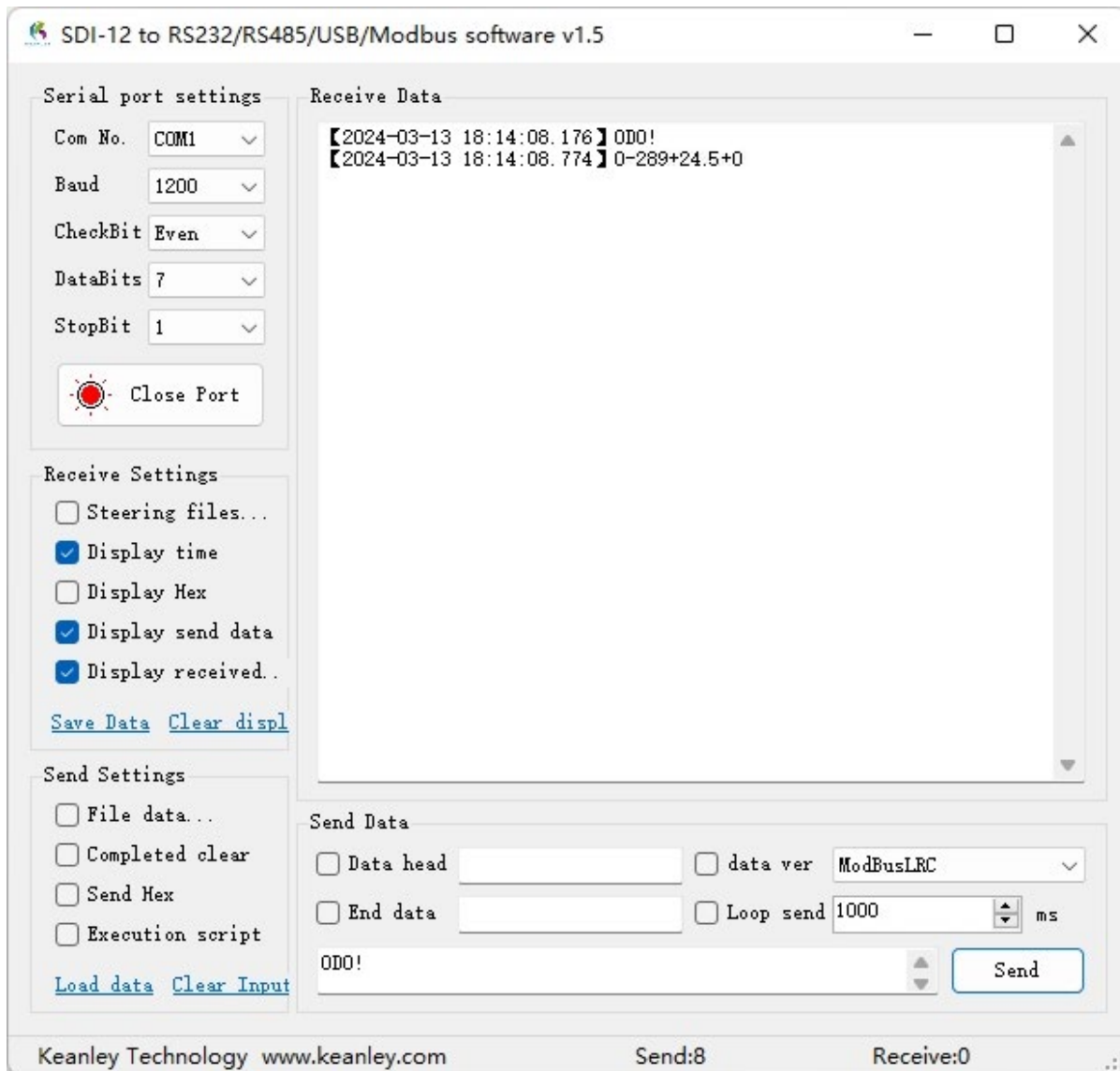
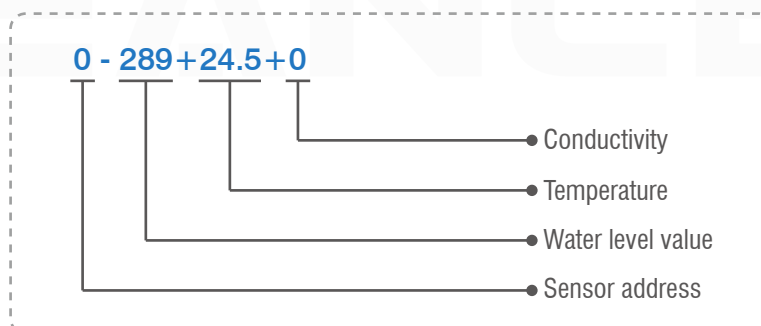

Figure 12. Obtaining sensor data interface

When using the sensor for the first time, the default address is 0. Enter ODO! in the sending area and click send button, the data obtained is 0-289+24.5+0. According to the CTD-100 sensor instruction manual, parsing the returned data is as follows.



Refer to page 19 for other SDI-12 commands



Send: The oscillogram feedback of ODO! is shown in Figure 13.

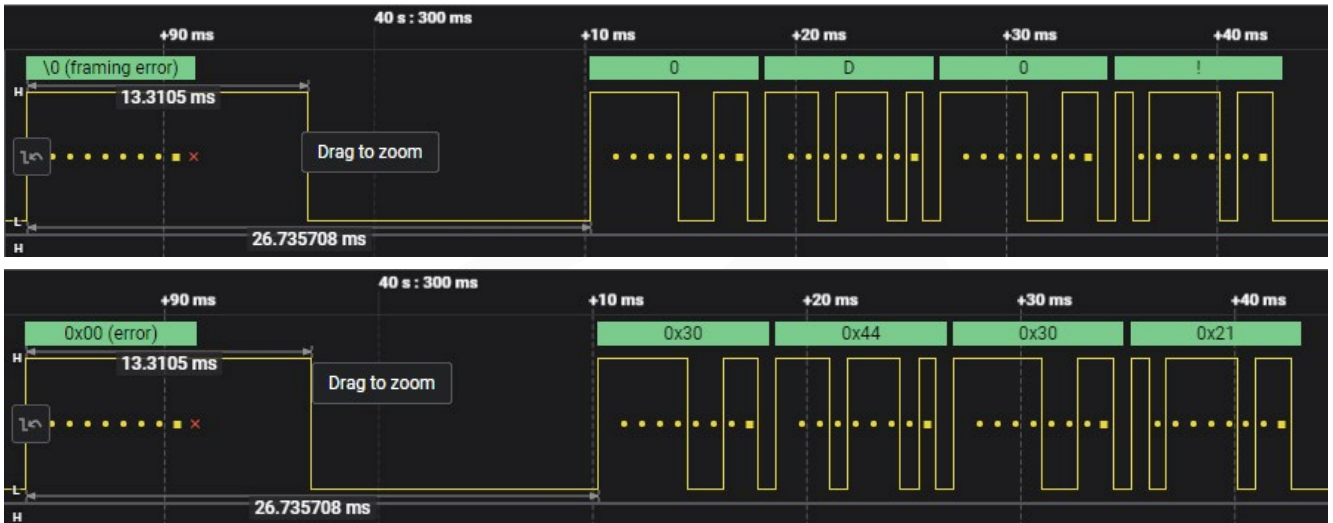

Figure 13. Oscillogram

The waveform feedback of the returning value characters 0-289+24.5+0 is shown in Figure 14.

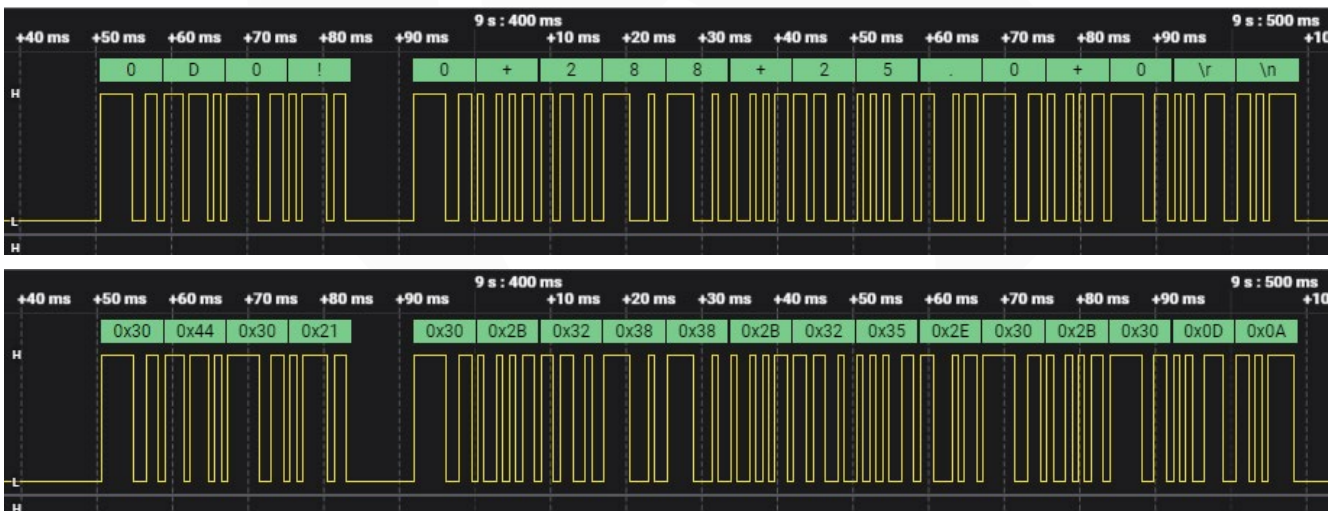

Figure 14. Oscillogram



Recommended SDI-12 circuit

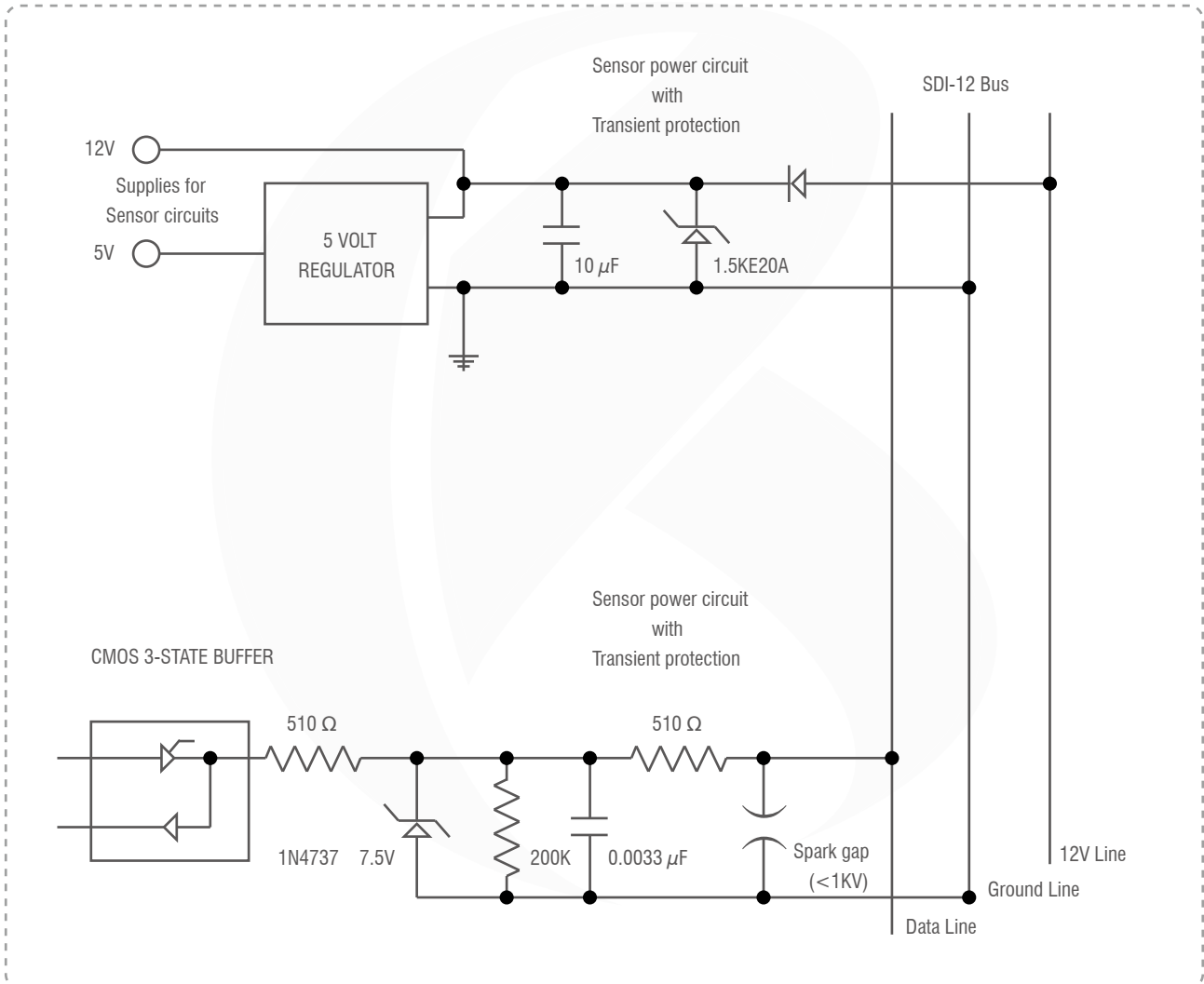

Figure 15. Recommended SDI-12 circuit



Commands and replies of SDI-12

Name	Command	Reply
Interrupt signal	Continuous 12ms blank number	None
Confirm activation	a!	a<CR><LF>
Send verification	al!	Allccccccmmmmmmvvvx...xx<CR><LF>
Address change	aAb!	B<CR><LF> (This command is only supported when the sensor supports software to change the address)
Address query	?!	a<CR><LF>
Start measurement	aM!	atttn<CR><LF>
Start measurement with CRC*	aMC!	atttn<CR><LF>
Send data	aD0!	a<values><CR><LF> or a<values><CRC><CR><LF>
	-	a<values><CR><LF> or a<values><CRC><CR><LF>
	-	a<values><CR><LF> or a<values><CRC><CR><LF>
	-	a<values><CR><LF> or a<values><CRC><CR><LF>
	aD9!	a<values><CR><LF> or a<values><CRC><CR><LF>
Additional measurements	aM1!	atttn<CR><LF>
	-	atttn<CR><LF>
	-	atttn<CR><LF>
	-	atttn<CR><LF>
	aM9!	atttn<CR><LF>
Additional measurement with CRC	aMC1!...aMC9!	atttn<CR><LF>
Start verification	aV!	atttn<CR><LF>



Name	Command	Reply
Start concurrent measurement	aC!	attn<CR><LF>
Start concurrent measurement with CRC	aCC!	attn<CR><LF>
Additional concurrent measurement	aC1!	attn<CR><LF>
	-	attn<CR><LF>
	-	attn<CR><LF>
	-	attn<CR><LF>
	aC9!	attn<CR><LF>
Additional concurrent measurement with CRC	aCC1!...aCC9!	attn<CR><LF>
Continuous measurement	aR0!...aR9!	a<values><CR><LF> (same format as D command)
Continuous measurement with CRC	aRC0!...aRC9!	a<values><CRC><LF> (same format as D command)

Table 12. Commands and replies of SDI-12



Connectable sensor brands









Mode	Function Classification	Brand	Logo
SDI-12	Environmental monitoring instruments	Vaisala (Finland)	
		GILL (U.K)	
		R.M.Young (U.S)	
	Measuring and metrologic instruments	METER (U.S)	
		Campbell (U.S)	
		Apogee (U.S)	
		ACCLIMA (U.S)	
		Stevens (U.S)	
		OTT (Germany)	
		Notes	Any sensor that meets the SDI-12 protocol standard can be connected (* only partial brands are shown). Non-standard protocols can be customized.

Table 13. Connectable sensor brands

